

★ KICKER CONVERSION KIT ★
INSTRUCTION MANUAL



Konami Inc.

1555 BRUMMEL AVENUE, ELK GROVE VILLAGE, IL 60007
TELEPHONE: (312) 364-6633 FAX: (312) 364-1368 TELEX: 6871385 KONAM UW

KICKER™ and **Konami**® are registered
trademarks of Konami Industry Co., Ltd.
© 1985 Konami. All rights reserved.

TABLE OF CONTENTS

	Page		Page
Conversion Kit Contents	1	Monitor Info.	5
Table of Contents	1	Wiring Harness Color Code	6
Introduction	2	Wiring Diagram	7
Recommended Control Panel Layouts	2	Technical Information	8
Graphics	3	Dip Switch Setting	9
Monitor Specifications	4	User Information Warning	Back Cover

CONVERSION KIT CONTENTS:

- MAIN PRINTED CIRCUIT BOARD
- P.C.B. CAGE (FCC REQUIRED)
- CONNECTING WIRING HARNESS
- 6 SETS — BUTTON ASSEMBLIES
- 4-WAY JOYSTICK
- MARQUEE (HEADER)
(1/8" acrylic sheet)
- ONE SET SIDE PANEL GRAPHICS (left & right)
- CONTROL PANEL OVERLAY
- CONTROL PANEL DECALS
instruction decals/button decals (2 sets)
- MANUAL
- REGISTRATION CARD

REPLACEMENT ACCESSORIES ARE AVAILABLE THROUGH YOUR DISTRIBUTOR.

THIS KIT USABLE FOR COCKTAIL AND UPRIGHT VIDEO GAMES WITH A RASTAR SCAN MONITOR WHICH IS OR CAN BE MOUNTED VERTICALLY.

KICKER INTRODUCTION

KONAMI CONVERSION KITS are the most complete conversion kits available today. Every detail has been carefully considered, designed and packaged to provide you the means of easily producing a professional conversion.

These kits have all the accessories to easily convert your UPRIGHT or COCKTAIL video game.

We strongly urge you to FULLY STUDY this instruction manual BEFORE you begin your conversion. It contains step-by-step instructions, schematic diagrams and suggestions on how to install your Konami Conversion Kit and maximize your profits.

KICKER can be installed in any vertically mounted raster scan monitor game.

Everything you will need to construct your new game is provided in this kit. All accessory parts — wiring harness, joystick, etc. are custom made for KICKER by top engineers experienced in the coin-op industry. A 4-way joystick (as provided) MUST be used.

The Player Instruction and Button Control decals are made of a non-destructible acrylic material specifically to keep the player from peeling them off. Should you convert a cocktail table game, KICKER is supplied with 2 sets of button decals.

SAVE YOURSELF TIME AND MONEY

The following P.C.B.'s are interchangeable with KICKER P.C.B.'s

Super Cobra • Scramble • Pooyan • Locomotion • Circus Charlie

L'il Hustler • Juno First • Time Pilot • Gyruss • Tutankham • Turtles

Super Basketball • Mega Zone • Pandora's Palace • Time Pilot '84 • Track 'n' Field • Hypersports

Frogger (60% — check pin print-out) • Amidar • Roc 'N Rope • The End

In other words, your KICKER will plug right into existing edge connectors of the games listed above — be sure to check your pin print-out. (Keep in mind that Kicker is designed as a vertical game.)

NEW FEATURE — DUAL CONTROL

By moving SW#2 of dip switch bank #3 to the "on" position, you are now in the dual control upright mode. This allows you to set up an upright game with two sets of controls rather than one set. The first set of controls should be hooked up to the 1P set of wires; the second set to the 2P wires (see wiring diagrams). Each player still challenges the "computer-controlled" opponent (alternating play). This does not allow simultaneous interaction of players on the video screen.

SINGLE CONTROL LAYOUT

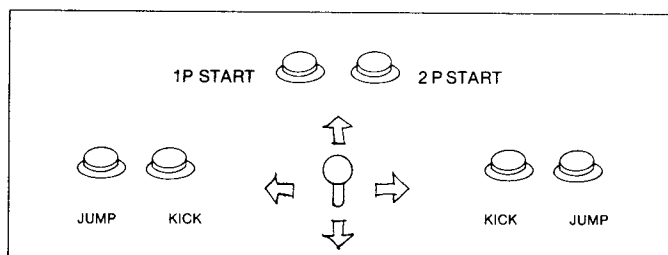

DUAL CONTROL LAYOUT

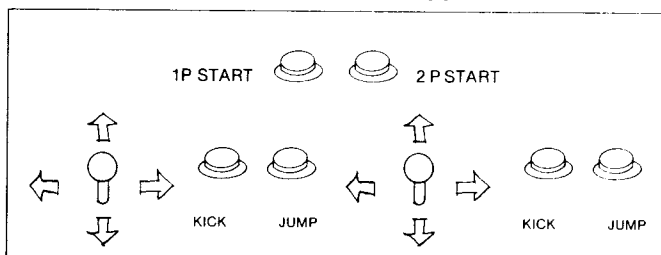

PUTTING YOUR BEST GAME FORWARD

PREPARATION:

For best results, all old graphics should be removed completely from the cabinet. "Stick-on" graphics can be removed by using a hairdryer or hot air device. The heat from the dryer will loosen the adhesive, allowing you to easily peel them off — any adhesive residue can be cleaned off with acetone and a soft dry cloth. (DO NOT USE ACETONE ON SURFACES PAINTED WITH FLAT PAINT).

TOOLS YOU NEED:

1. Foaming Aerosol (such as "Windex").
2. Soft Squeegee.
3. X-Acto Knife.

SIDE PANEL DECALS

1. Spray area of cabinet where Side Panel decals are to be applied with foaming aerosol or a mild soap solution.
2. Remove protective backing from decals.
3. Position decals into place.
4. With a soft squeegee, beginning from the center of the decal, slowly and evenly press out excess foam until you achieve a smooth finish.

5. Allow to set approximately 2 to 3 hours before handling. Maximum adherence is achieved in 48 to 72 hours.
6. Trim side decal to fit your cabinet.

CONTROL PANEL OVERLAY:

1. Refer to Recommended Control Panel Layout on page 4.
2. Drill any new holes needed.
3. Plug any holes that will not be used. (A permanent epoxy filler works well for this step.)
4. Pre-position the overlay prior to removing the backing.
5. Slowly apply the overlay — inch by inch on the control panel, removing the backing as you apply it.
6. Once it's in place, by using an X-Acto knife, cut around the button and joystick placements.

INSTRUCTION/BUTTON DECALS:

Apply the Player Instruction, Button and 1 Player/2 Player decals in their respective positions. Apply pressure liberally. Allow to set as long as possible before putting game on location.

NOTE: Maximum adherence is achieved in 48 to 72 hours.

MARQUEE

(WEAR PROTECTIVE GLASSES WHILE TRIMMING MARQUEE)

1/8" Acrylic Marquee should be cut to fit your game. DO NOT remove protective mask until this is done.

One way of cutting your Marquee is as follows: (Be sure to protect painted side of Marquee from any surface which may scratch or mar finish).

CUTTING WITH A KNIFE OR SCRIBER

Acrylic sheet up to 3/16" thick may be cut by a method similar to that used for cutting window glass. Use a scribe of some kind — a scribing knife such as the one pictured, a metal scribe, an awl, or even a sturdy craft knife — to score the sheet. Draw the scribe several times (7 or 8 times for a 3/16" thick piece) along a straight edge held firmly in place. It is best not to remove the protective masking. Make the cuts carefully using firm, even pressure. For best results make each stroke cleanly off the edge of the sheet.

Then, clamp the acrylic sheet or hold it rigidly under a straight edge with the scribe mark hanging just over the edge of a table. Protect your hands with a cloth, and apply a sharp downward pressure to the other side of the sheet. It will break along the scratch. Scrape the edges to smooth any sharp corners. This method is not recommended for long breaks or thick material.

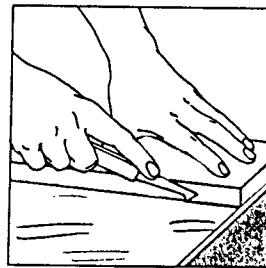

Always draw the scribing knife along a straight edge.

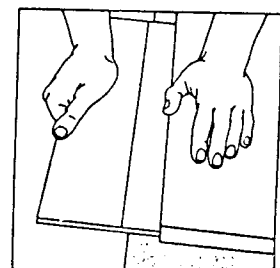

Break sheet over edge of table after scribing.

KICKER: MONITOR SPECIFICATIONS

Kicker requires a vertically mounted monitor. It also generates composite negative sync. If your monitor is composite positive sync, you will have to change to composite negative sync.

- (1) To alternate composite positive sync to composite negative sync, use 7404 IC or 74LS04 IC. The signal on the output pin from the P.C.B. is a combination of H-sync and V-sync.

NOTE: Please refer to Figure 2.

FIGURE 2:

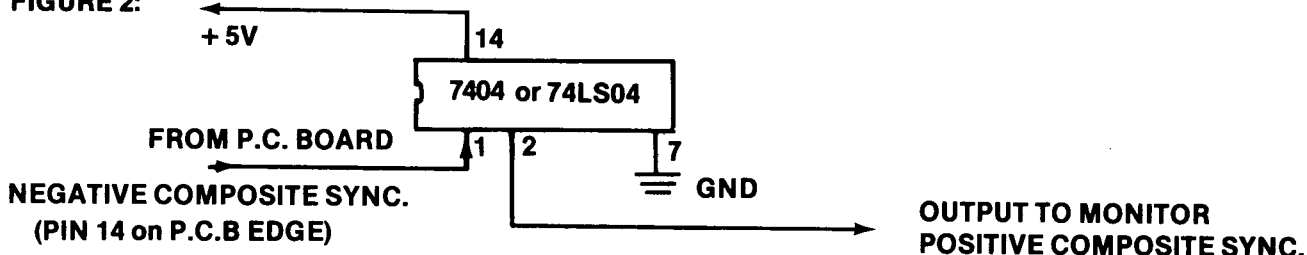

(+ 5V and GND should be taken out of the P.C. Board.)

- (2) Separate Sync modification for KICKER if your monitor has "Separate Sync" input. (For example "Electrohome brand" and Wells-Gardner brand.")

Step 1

WIRING HARNESS

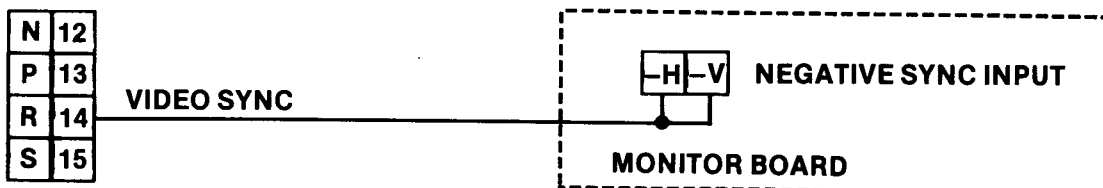

If the picture is still not stable...

Step 2

Prepare Hook-up wire. (For example "Electrohome brand.")

WIRING HARNESS

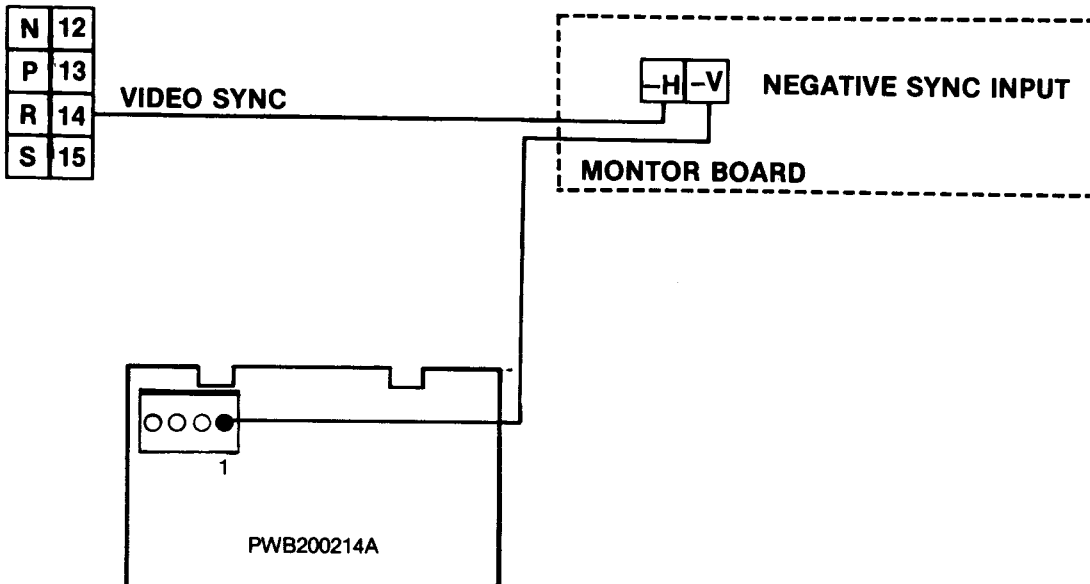

KICKER: MONITOR INFO.

SERVICE INSTRUCTIONS

NOTE: All monitors are equipped with automatic degaussing coils (L701) which demagnetize the picture tube every time the monitor is turned on after being off for a minimum of 5 minutes. Should any part of the chassis become magnetized it will be necessary to degauss the affected area with a manual degaussing coil. Move the coil slowly around the CRT face and all surrounding metal parts. Then slowly withdraw for a distance of 6 feet before turning off.

1.0 BLACK LEVEL CONTROL ADJUSTMENT

This control has been set at the factory and should not need further attention, however, when the game is connected a slight adjustment of VR201 may be necessary to obtain the proper black level (the black portion of the picture just extinguished).

2.0 VERTICAL SIZE (HEIGHT)

Location of this control is shown in Fig. 1. This control must be adjusted slowly, if necessary, until the picture or test pattern attains the correct vertical proportions.

3.0 CIRCUIT PROTECTION

A 4.0A pigtail fuse, mounted on the Main Board has been provided to protect the Power Output Circuit.

4.0 FOCUS

Adjust the focus control, located on the HV unit (T352), for maximum over-all definition and fine picture detail.

5.0 HORIZONTAL HOLD CONTROL ADJUSTMENT, VR351 (See Fig. 1)

A warm-up period of at least five minutes should be allowed before alignment is carried out. With the monitor being driven from the game signal, short TP601 to TP31. Adjust VR351 until the picture stops sliding horizontally. Remove the short.

6.0 HORIZONTAL VIDEO POSITION

If the video is off center on the raster some compensation can be made by adjusting this control.

7.0 VERTICAL RASTER POSITION ADJUSTMENT

If the video is off center vertically, (short dimension of picture tube) some compensation can be made by moving the vertical raster position adjustment jumper to either positions "U" or "D".

8.0 HORIZONTAL RASTER POSITION ADJUSTMENT

If the video is off center horizontally (long dimension of the picture tube) some compensation can be made by moving the horizontal raster position adjustment jumper to either positions "R" or "L".

9.0 HORIZONTAL WIDTH ADJUSTMENT

The horizontal width coil is a hexagonal tuning tool adjustment. This control must be adjusted slowly, if necessary, until the picture or test pattern attains the correct horizontal proportions.

* KONAMI GAMES ARE ALL NEGATIVE COMPOSIT SYNC. USE THE THREE PIN CONNECTOR ON THE MONITOR.

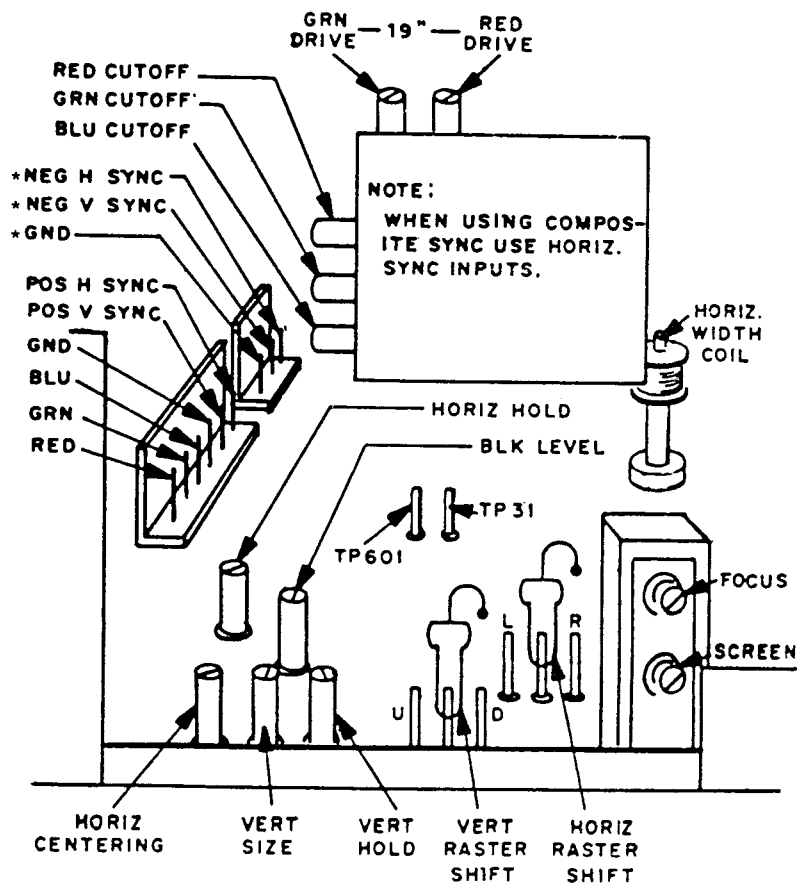

FIGURE 1

KICKER: WIRING HARNESS

WIRE COLOR KEY:		Unlettered Side (Solder Side)	Lettered Side (Parts Side)
		A (EMPTY)	1 + 12V DC
RED/GREEN		B SPEAKER OUT	2 SPEAKER OUT
RED/YELLOW		C * 2P KICK	3 2P JUMP *
BROWN/YELLOW		D * 2P LEFT	4 2P RIGHT*
VIOLET/WHITE		E 1P START	5 2P START
ORANGE/WHITE		F 1P JUMP	6 2P UP*
RED/WHITE		H 1P KICK	7 SERVICE SW
BLUE/WHITE		J 1P RIGHT	8 1P LEFT
BLACK/WHITE		K 1P UP	9 2P DOWN*
RED/GRAY		L COIN 1	10 COIN 2
GRAY/WHITE		M 1P DOWN	11 COIN COUNTER 1
WHITE/PINK		N (NOT USED)	12 COIN COUNTER 2
GREEN/BROWN		P VIDEO GREEN	13 VIDEO BLUE
RED/BROWN		R VIDEO RED	14 VIDEO SYNC
		S (EMPTY)	15 (NOT USED)
BLACK		T GND	16 GND
BLACK		U GND	17 GND
RED		V + 5V DC	18 + 5VDC
			ORANGE
			ORANGE/GREEN
			ORANGE/YELLOW
			BLUE/YELLOW
			VIOLET/YELLOW
			BLACK/YELLOW
			ORANGE/GRAY
			BROWN/WHITE
			GRAY/YELLOW
			BLUE/GRAY
			GREEN/GRAY
			YELLOW/GRAY
			BLUE/BROWN
			WHITE/BROWN
			YELLOW/PINK
			BLACK
			BLACK
			RED

(BASE COLOR/LINE COLOR)

*Cocktail Table or Dual Control
Upright Only

KICKER WIRING DIAGRAM

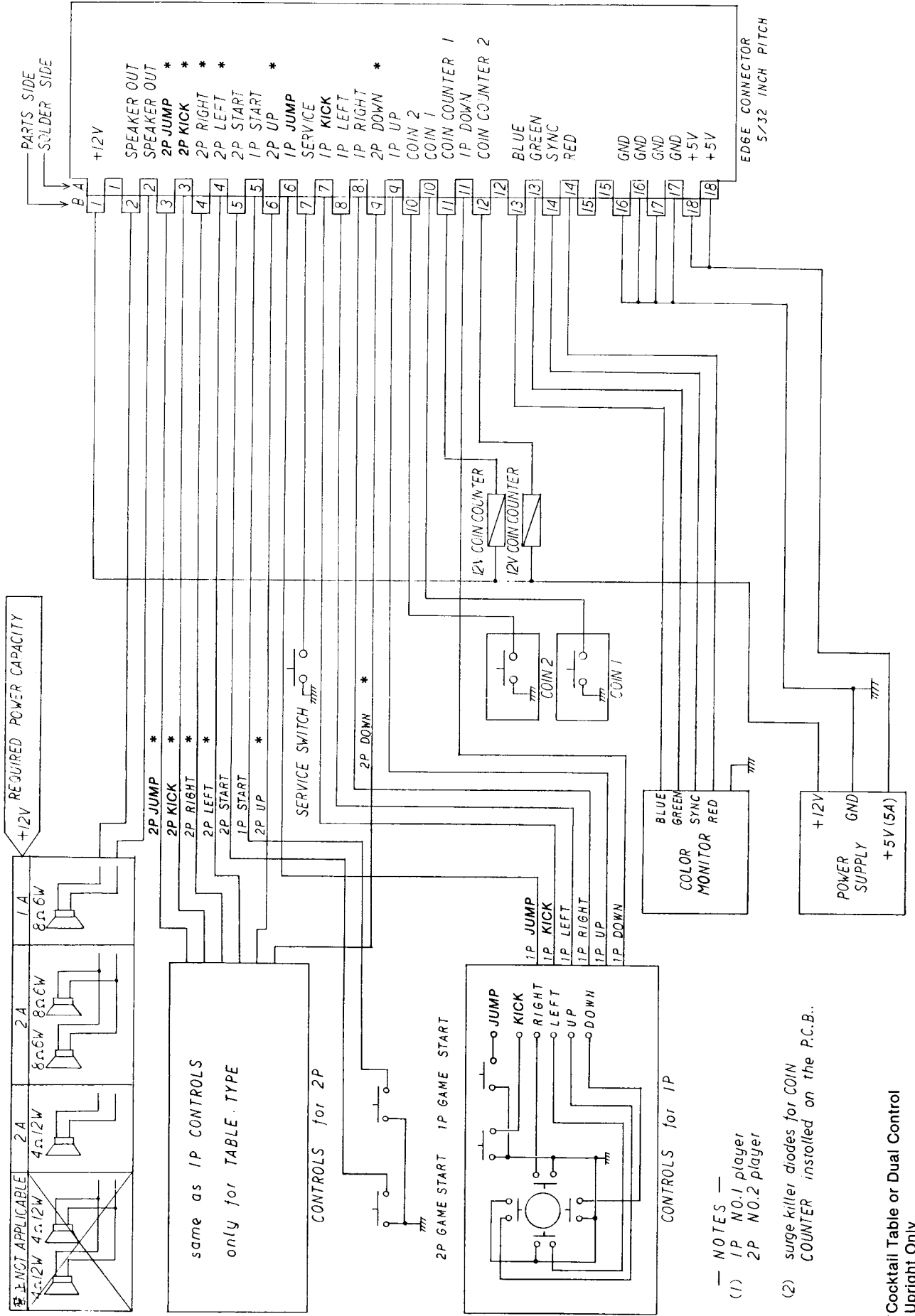

- NOTES —
- (1) 1P NO.1 player
 - 2P NO.2 player
 - (2) surge killer diodes for COIN COUNTER installed on the P.C.B.

*Cocktail Table or Dual Control Upright Only

KICKER: TECHNICAL INFORMATION

(1) Required Power Capacity

- + 5V DC 7A or more.
- + 12V DC See Figure 1 below

Figure 1:

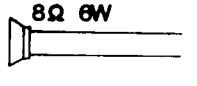
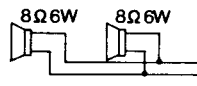
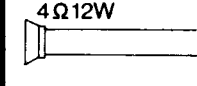
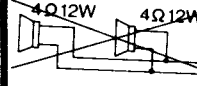
SPEAKER				
Required Power Capacity	12V 1A	12V 2A	12V 2A	Not Applicable

(2) Signal output

- R(red) analog, positive
- G(green) analog, positive
- B(blue) analog, positive
- Sync. H-V composite negative

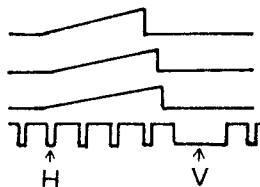

DIAGNOSTIC PROCEDURES

AUTOMATIC SELF-TEST — Upon “Power On”, this system will automatically test ROMS and VIDEO RAMS. The screen will display pass or conditions as follows:

ROM 1 OK
ROM 2 OK = TEST PASSED

RAM 1 OK
RAM 2 OK = TEST PASSED

If there is a problem, before contacting your distributor:

1. Check that all chips on board and wiring connections are tight.
2. Check output from power supply at the board. (Do not just check at the power supply as voltage drops may occur over the length of the wire.)

MANUAL TEST — A more detailed five step diagnostic may be performed by moving SW3 of Dip Switch Bank #3 to the “on” position while power to game is off. Turn power “on” and proceed as follows:

1. COLOR TEST

The screen will display V RAM color & OBJ color blocks. If a block shows any irregularities (e.g., lines or dots in color blocks), this could be due to a failure of VIDEO RAM, COLOR RAM, or OBJ CIRCUITS. Use these blocks to further adjust monitor focus and colors.

2. SWITCH TEST

From color test, press One Player Start and the screen will display all switches with a zero (0) to the right. When a switch is activated the zero (0) should change to a one (1).

3. COIN COUNTER TEST

From switch test, press One Player Start and the screen will display “coin counter”. While number one (1) is shown, counter one should pulse eight times. When number two (2) is shown, counter two should pulse eight times also.

4. DIP SWITCH SETTINGS

Press Player 1 and the screen will display most of the programmable features with their respective settings. These settings should correspond to the positions of the dip switches.

5. SOUND TEST

From dip switch settings, press One Player Start. The game will go through all sounds of Kicker’s program.

TO EXIT DIAGNOSTICS —

TURN POWER OFF AND RETURN SW3 TO OFF POSITION. THEN TURN POWER BACK ON.

DIP SWITCH SETTINGS

DIP SW No. 1 Settings

Coin 1 Switch Set

SW	4	3	2	1	COIN	PLAY
•	OFF	OFF	OFF	OFF	1	1
			OFF	ON	1	2
			ON	OFF	1	3
			ON	ON	1	4
	OFF	ON	OFF	OFF	1	5
			OFF	ON	1	6
			ON	OFF	1	7
			ON	ON	2	1
	ON	OFF	OFF	OFF	2	3
			OFF	ON	2	5
			ON	OFF	3	1
			ON	ON	3	2
	ON	ON	OFF	OFF	3	4
			OFF	ON	4	1
			ON	OFF	4	3
			ON	ON	FREE PLAY	

Coin 2 Switch Set

SW	8	7	6	5	COIN	PLAY
•	OFF	OFF	OFF	OFF	1	1
			OFF	ON	1	2
			ON	OFF	1	3
			ON	ON	1	4
	OFF	ON	OFF	OFF	1	5
			OFF	ON	1	6
			ON	OFF	1	7
			ON	ON	2	1
	ON	OFF	OFF	OFF	2	3
			OFF	ON	2	5
			ON	OFF	3	1
			ON	ON	3	2
	ON	ON	OFF	OFF	3	4
			OFF	ON	4	1
			ON	OFF	4	3
			ON	ON	INVALIDITY	

DIP SWITCH NO. 2 SETTINGS

THE NUMBER OF PLAYER'S LIFE

SW	1	2	NUMBER
•	OFF	OFF	2
	ON	OFF	3
	OFF	ON	5
	ON	ON	7

SOUND IN ATTRACT MODE

SW	8	SOUND
•	OFF	OFF
	ON	ON

CHANGE OF TABLE OR UP-RIGHT

SW	3	TYPE
•	OFF	TABLE
	ON	UP-RIGHT

DIP SWITCH NO. 3 SETTINGS

Video Screen Flip

SW	1	
•	OFF	NORMAL
	ON	UPSIDE DOWN

BONUS SET

SW	4	5	BONUS POINTS
•	OFF	OFF	At 30,000 Pts. & Every 70,000 Pts. Thereafter
	ON	OFF	At 40,000 Pts. & Every 80,000 Pts. Thereafter
	OFF	ON	40000 PTS
	ON	ON	50000 PTS

Single/Dual Control Upright

SW	2	TYPE
•	OFF	SINGLE UPRIGHT CONTROL
	ON	DUAL UPRIGHT CONTROL

Game Test Mode

SW	3	MODE
•	OFF	GAME MODE
	ON	CHECK MODE

*SW 4: NOT USED

•SHOWS NORMAL SETTING

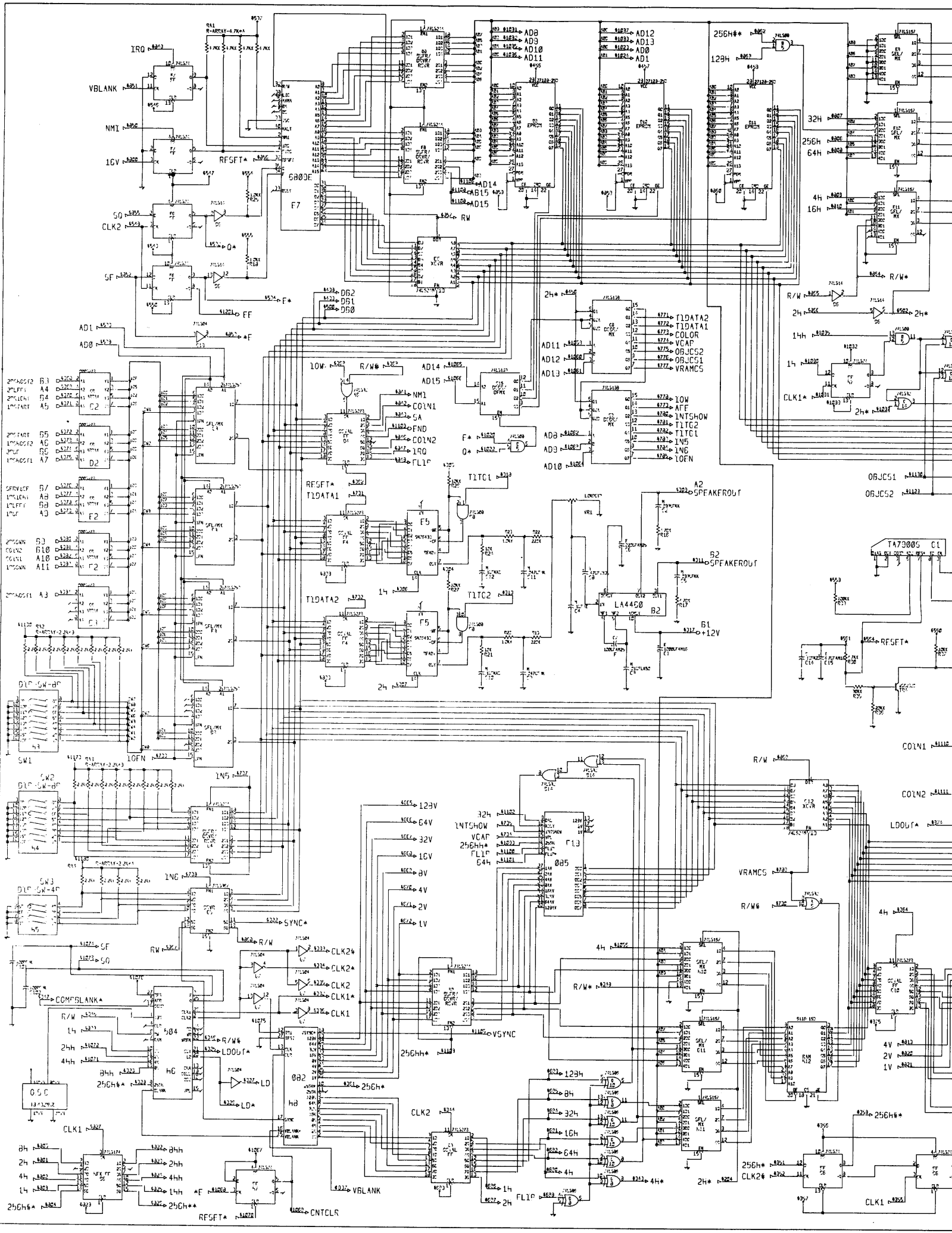

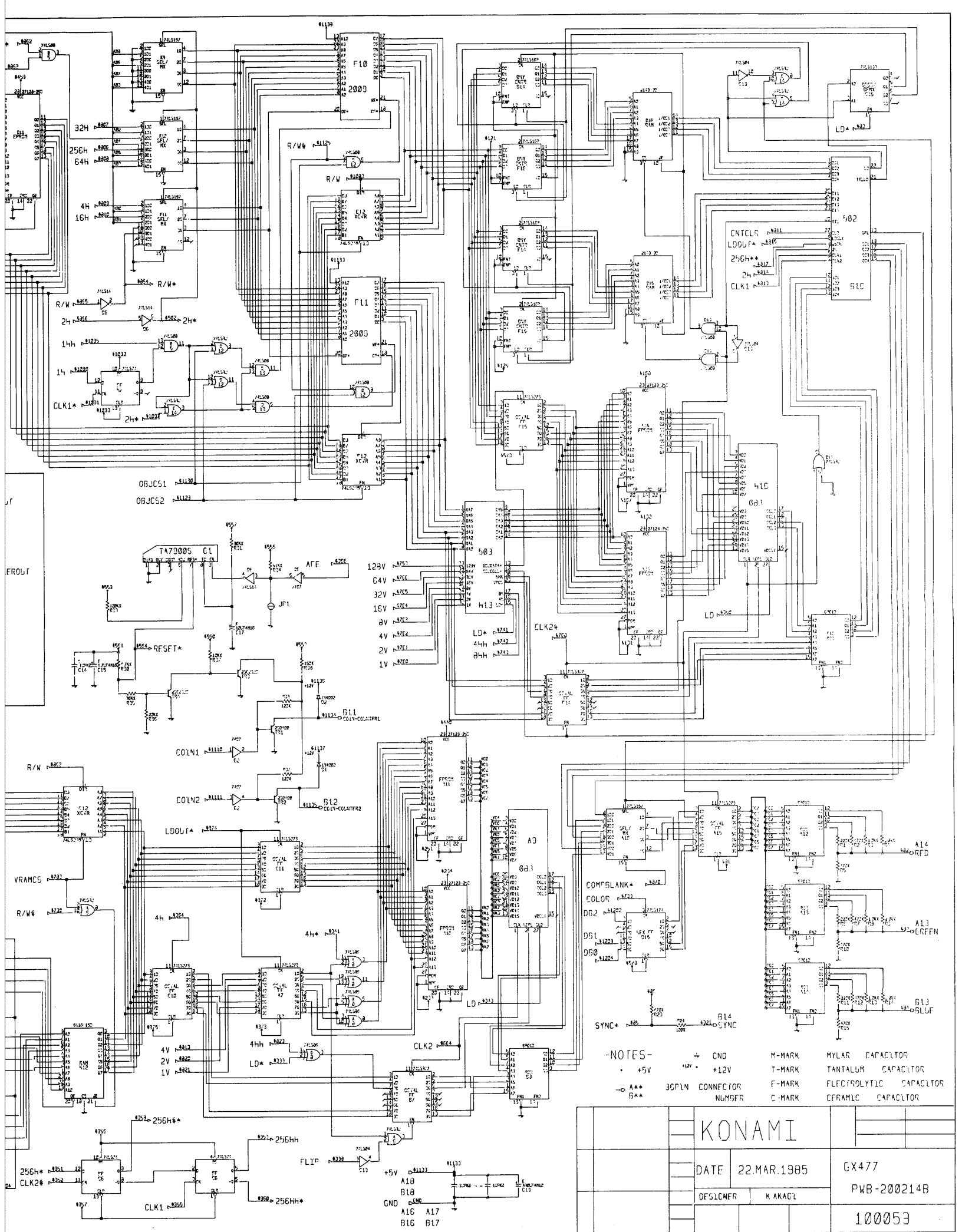

EROUT

R/W

VRAMCS

R/W

256H*

CLK2*

CLK1*

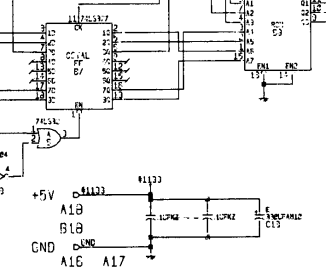
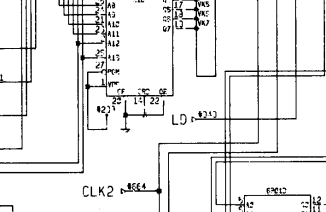
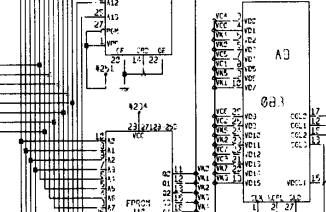
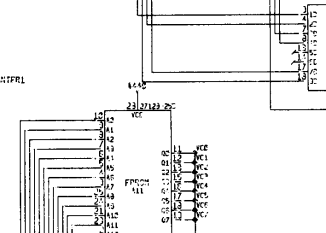
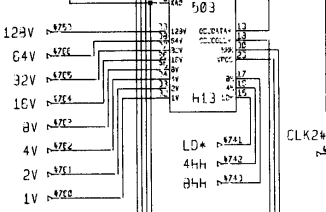
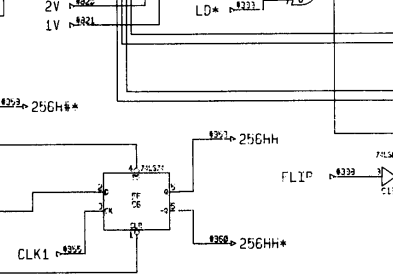
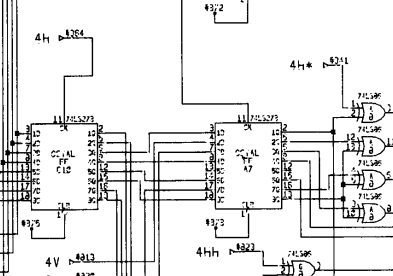
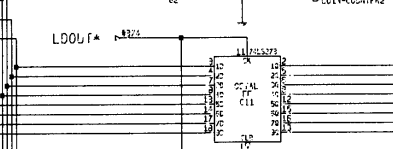
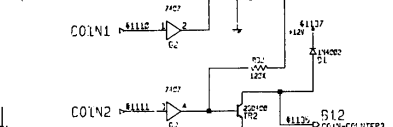
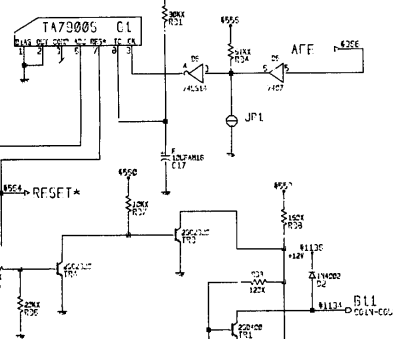

- NOTES-
- +5V
 - 36PIN CONNECTOR NUMBER
 - CND +12V
 - M-MARK MYLAR CAPACITOR
 - T-MARK TANTALUM CAPACITOR
 - F-MARK ELECTROLYTIC CAPACITOR
 - C-MARK CERAMIC CAPACITOR

KONAMI		
DATE	22.MAR.1985	GX477
DESIGNER	K AKACL	PWB-200214B
		100053